

TECHNICAL DATA

ROLF BENZ 650



**ROLF
BENZ**

- Seat and back made out of moulded wood
- Four leg circular tubular base metal, options:
 - Smooth steel, powder-coated, matt
 - RAL 7022 Umbra grey
 - RAL 9017 Traffic black
 - Steel high-gloss chrome
- Four leg solid wood, colorless painted, options:
 - Oak
 - Oak black pigmented
 - American walnut (against surcharge)
- Chair with upholstery on seat and back

Seat and back made out of moulded wood

- Four leg circular tubular base metal, options:
 - Smooth steel, powder-coated, matt
 - RAL 7022 Umbra grey
 - RAL 9017 Traffic black
 - Steel high-gloss chrome
- Four leg solid wood, colorless painted, options:
 - Oak
 - Oak black pigmented
 - American walnut (against surcharge)
- Seat and back made of polyurethane foam, built up in coordinated layers varying in height and firmness and with a bonded non-woven polyester cover
- Seat cushions quilted underneath with non-woven polyester and a polyurethane padding

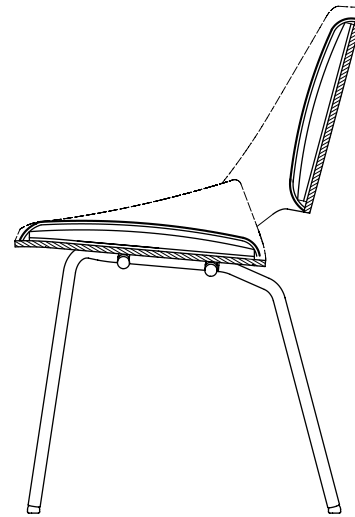

Chair four-leg metal

Chair four-leg wood

Footstool with metal leg

Footstool with wood leg

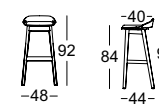
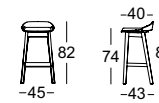
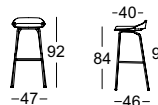
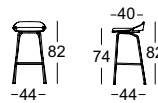
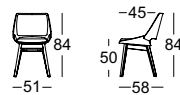
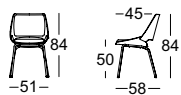

**ROLF
BENZ**